

Size Guide

Highbeach Dining

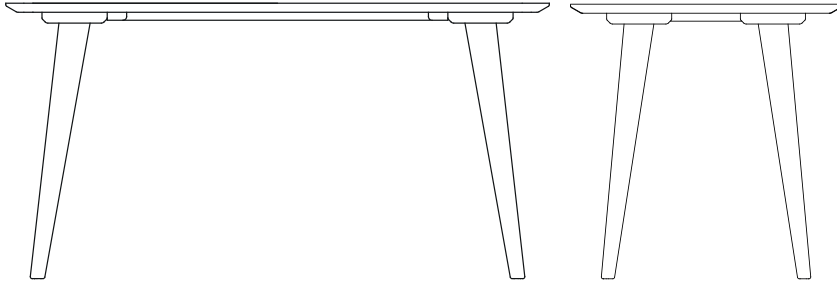



When it comes to furniture, the smallest measurement can transform a space. It's easy to find something you love, but getting your head around sizing is the hard part.

How many people can I sit around this table? Will this desk work for myself and my partner? Will it fit right in the kitchen?

Our research team and our product team have joined forces to create a size range that will help you maximise floor space without compromising on seating. Let's have a look at it.

Symbols Key

 Comfortable Seating
 Tight Seating



Place Setting
56x32cm



115cm

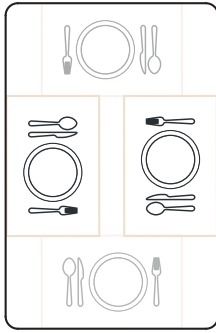

115x75cm

Comfy for 2, tight for 4

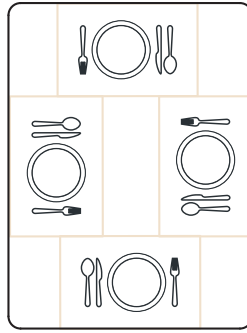

115x87cm

Small for 4

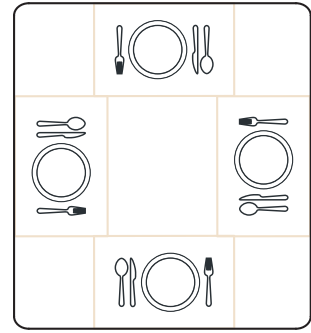

115x105cm

Small for 4



150cm

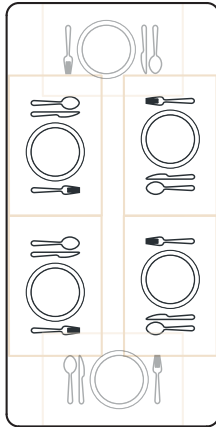

150x75cm

Small for 4, tight for 6

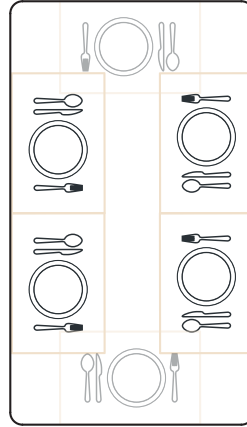

150x87cm

Comfy for 4, tight for 6

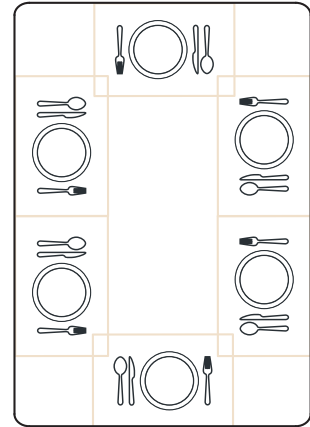

150x105cm

Small for 6



180cm

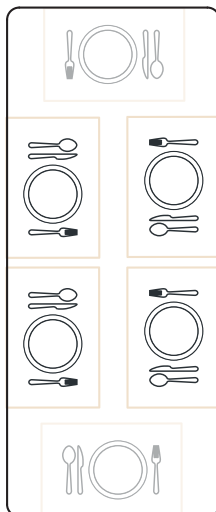

180x75cm

Comfy for 4, tight for 6

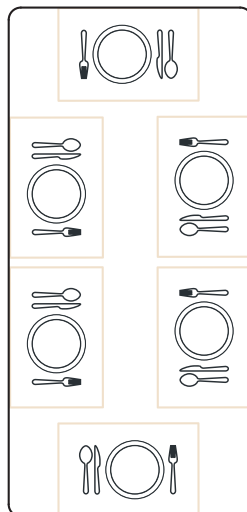

180x87cm

Comfy for 4. Small for 6

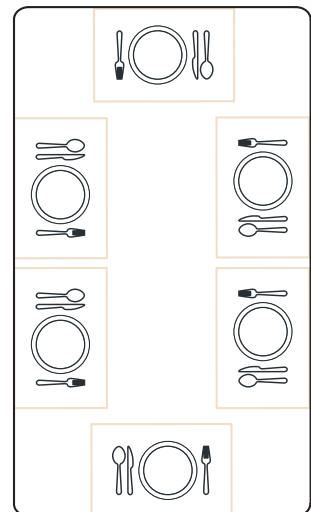

180x105cm

Comfy for 6



200cm

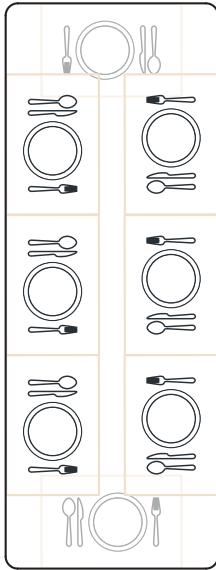

200x75cm

Small for 6, tight for 8

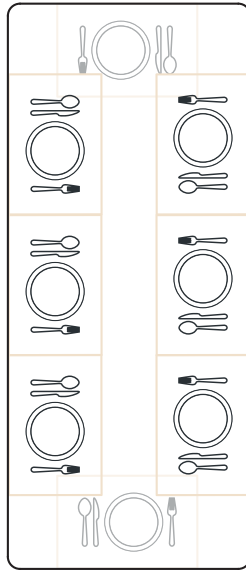

200x87cm

Comfy for 6, tight for 8

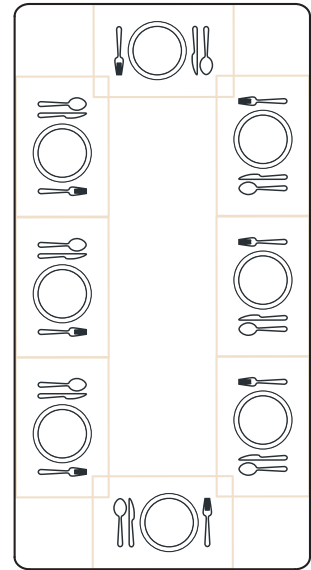

200x105cm

Comfy for 6. Small for 8



230cm

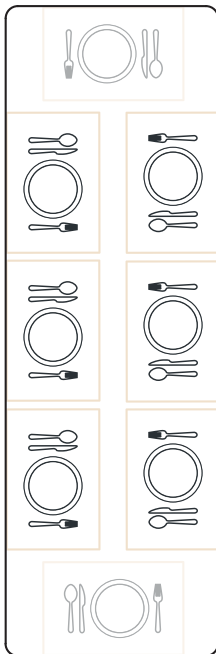

230x75cm

Comfy for 6, tight for 8

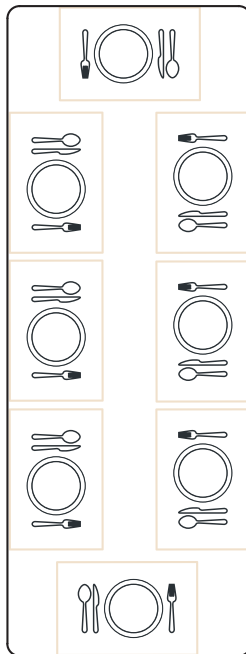

230x87cm

Comfy for 8

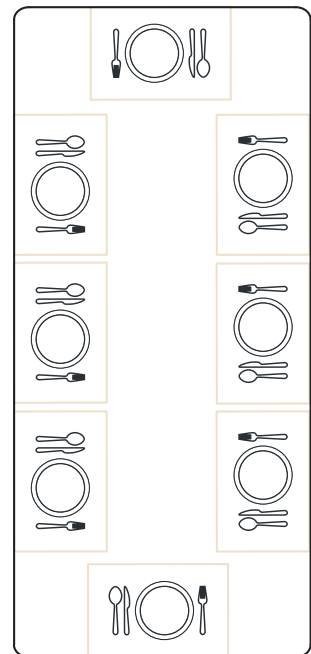

230x105cm

Comfy for 8



Size Guide

Highbeach Bench

Recessed Bench

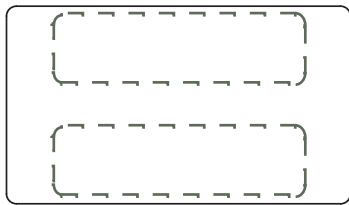
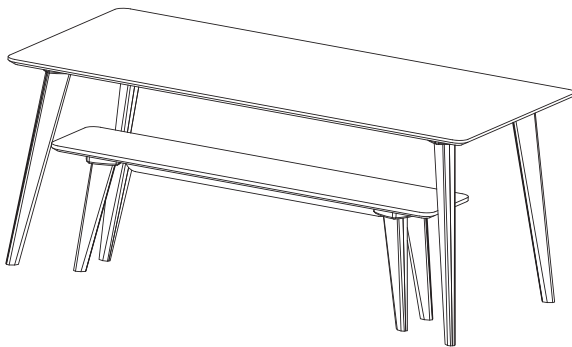

Each bench fully recesses when not in use.

More floor space,
less seating space

Non Recessed Bench

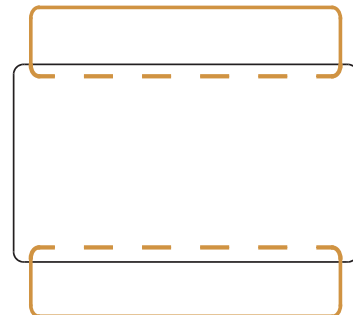
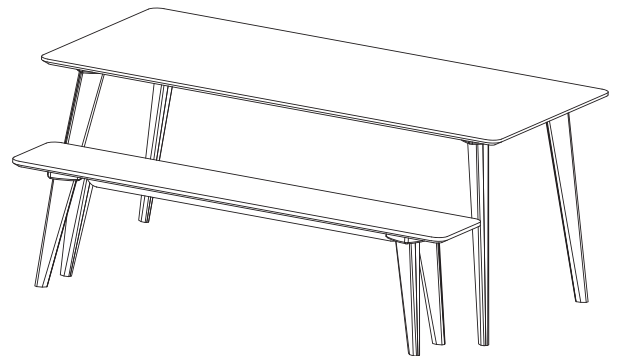

Each bench slides away by 5cm when not in use.

More seating space,
less floor space

Our guide for each table choice follows this page...



**Chosen
Table Size**

**Matching
Recessed Bench**

**Matching
Non Recessed Bench**

115cm

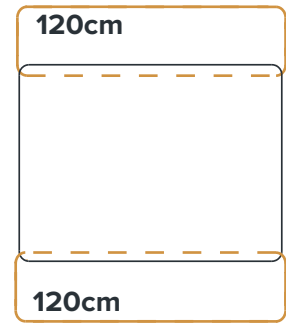

150cm

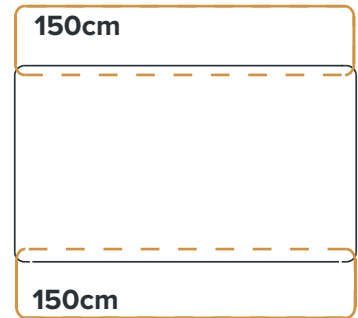
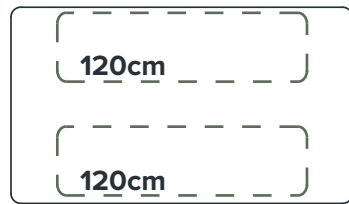

180cm

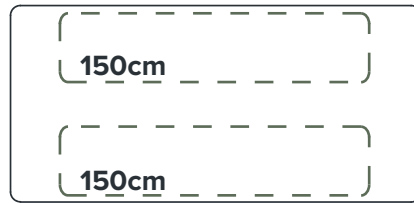

200cm



230cm

